

INSTRUCTION MANUAL FOR



RUGER® 10/22® AUTOLOADING RIFLES



10/22 Takedown®



10/22® Carbine



10/22® Tactical



10/22® Target LITE

– RUGGED, RELIABLE FIREARMS® –



**READ THE INSTRUCTIONS AND
WARNINGS IN THIS MANUAL CAREFULLY
BEFORE USING THIS FIREARM**

© 2020 Sturm, Ruger & Co., Inc.

This manual may not be reproduced in whole or in part without the express written permission of Sturm, Ruger & Co., Inc.

**For Service on This Model Please Call:
(336) 949-5200 (See p. 37)**

THIS INSTRUCTION MANUAL SHOULD ALWAYS ACCOMPANY THIS FIREARM AND BE
TRANSFERRED WITH IT UPON CHANGE OF OWNERSHIP, OR WHEN THE FIREARM IS LOANED
OR PRESENTED TO ANOTHER PERSON

RUGER.COM

B 3/2020 R33

State-By-State Warnings

Certain states require by law that their own specified warning notices in larger-than-normal type be conspicuously included by the manufacturer, distributor or retailer with firearms sold in that state. Sturm, Ruger & Co., Inc. sells its products in compliance with applicable laws and regulations. Because our products may be sold in these states, we include the following:

California:

WARNING

“Firearms must be handled responsibly and securely stored to prevent access by children and other unauthorized users. California has strict laws pertaining to firearms, and you may be fined or imprisoned if you fail to comply with them. Visit the Web site of the California Attorney General at <https://oag.ca.gov/firearms> for information on firearm laws applicable to you and how you can comply.

Prevent child access by always keeping guns locked away and unloaded when not in use. If you keep a loaded firearm where a child obtains and improperly uses it, you may be fined or sent to prison.”

ADVERTENCIA

“Las armas de fuego deben manipularse de manera responsable y segura para evitar el acceso de niños y otros usuarios no autorizados. California tiene leyes estrictas relacionadas con armas de fuego, y usted puede ser multado o encarcelado si no las cumple. Visite el sitio web del Procurador General de California en <https://oag.ca.gov/firearms> para obtener información sobre las leyes de armas de fuego que le son aplicables y cómo puede cumplirlas.

A los niños los atraen las armas de fuego y las pueden hacer funcionar. Ellos pueden causarse lesiones graves y la muerte. Evite que los niños tengan acceso a las armas de fuego guardándolas siempre con llave y descargadas cuando no las esté utilizando. Si usted tiene un arma de fuego cargada en un lugar en que un niño tiene acceso a ella y la usa indebidamente, le pueden dar una multa o enviarlo a la cárcel.”

Connecticut:

“UNLAWFUL STORAGE OF A LOADED FIREARM MAY RESULT IN IMPRISONMENT OR FINE.”

Florida:

“IT IS UNLAWFUL, AND PUNISHABLE BY IMPRISONMENT AND FINE, FOR ANY ADULT TO STORE OR LEAVE A FIREARM IN ANY PLACE WITHIN THE REACH OR EASY ACCESS OF A MINOR UNDER 18 YEARS OF AGE OR TO KNOWINGLY SELL OR OTHERWISE TRANSFER OWNERSHIP OR POSSESSION OF A FIREARM TO A MINOR OR A PERSON OF UNSOUND MIND.”

Maine:

“ENDANGERING THE WELFARE OF A CHILD IS A CRIME. IF YOU LEAVE A FIREARM AND AMMUNITION WITHIN EASY ACCESS OF A CHILD, YOU MAY BE SUBJECT TO FINE, IMPRISONMENT OR BOTH. KEEP FIREARMS AND AMMUNITION SEPARATE. KEEP FIREARMS AND AMMUNITION LOCKED UP. USE TRIGGER LOCKS.”

Maryland:

“WARNING: Children can operate firearms which may cause death or serious injury. It is a crime to store or leave a loaded firearm in any location where an individual knew or should have known that an unsupervised minor would gain access to the firearm. Store your firearm responsibly!”

Massachusetts:

“WARNING FROM THE MASSACHUSETTS ATTORNEY GENERAL: This handgun is not equipped with a device that fully blocks use by unauthorized users. More than 200,000 firearms like this one are stolen from their owners every year in the United States. In addition, there are more than a thousand suicides each year by younger children and teenagers who get access to firearms. Hundreds more die from accidental discharge. It is likely that many more children sustain serious wounds, or inflict such wounds accidentally on others. In order to limit the chance of such misuse, it is imperative that you keep this weapon locked in a secure place and take other steps necessary to limit the possibility of theft or accident. Failure to take reasonable preventive steps may result in innocent lives being lost, and in some circumstances may result in your liability for these deaths.”

“IT IS UNLAWFUL TO STORE OR KEEP A FIREARM, RIFLE, SHOTGUN OR MACHINE GUN IN ANY PLACE UNLESS THAT WEAPON IS EQUIPPED WITH A TAMPER-RESISTANT SAFETY DEVICE OR IS STORED OR KEPT IN A SECURELY LOCKED CONTAINER.”

New Jersey:

“IT IS A CRIMINAL OFFENSE TO LEAVE A LOADED FIREARM WITHIN EASY ACCESS OF A MINOR.”

New York City:

“THE USE OF A LOCKING DEVICE OR SAFETY LOCK IS ONLY ONE ASPECT OF RESPONSIBLE FIREARM STORAGE. FOR INCREASED SAFETY, FIREARMS SHOULD BE STORED UNLOADED AND LOCKED IN A LOCATION THAT IS BOTH SEPARATE FROM THEIR AMMUNITION AND INACCESSIBLE TO CHILDREN AND UNAUTHORIZED PERSONS.”

North Carolina:

“IT IS UNLAWFUL TO STORE OR LEAVE A FIREARM THAT CAN BE DISCHARGED IN A MANNER THAT A REASONABLE PERSON SHOULD KNOW IS ACCESSIBLE TO A MINOR.”

Texas:

“IT IS UNLAWFUL TO STORE, TRANSPORT, OR ABANDON AN UNSECURED FIREARM IN A PLACE WHERE CHILDREN ARE LIKELY TO BE AND CAN OBTAIN ACCESS TO THE FIREARM.”

Wisconsin:

“IF YOU LEAVE A LOADED FIREARM WITHIN THE REACH OR EASY ACCESS OF A CHILD YOU MAY BE FINED OR IMPRISONED OR BOTH IF THE CHILD IMPROPERLY DISCHARGES, POSSESSES, OR EXHIBITS THE FIREARM.”

* * * * *

Please check with your licensed retailer or state police for additional warnings which may be required by local law or regulation. Such regulations change constantly, and local authorities are in the best position to advise you on such legal matters.

FIREARMS SAFETY IS YOUR RESPONSIBILITY
SAFETY MUST BE THE FIRST AND CONSTANT
CONSIDERATION OF EVERY PERSON WHO HANDLES
FIREARMS AND AMMUNITION.

This Instruction Manual is designed to assist you in learning how to use and care for your RUGER® 10/22® rifles properly. Please contact us if you have any questions.

Only when you are certain you fully understand the manual and can properly carry out its instructions should you practice loading, unloading, etc. with live ammunition. If you have any doubts about your ability to handle or use a particular type of firearm safely, you should seek supervised instruction. Such personalized instruction often is available from local firearm retailers, gun clubs or police departments. If none of these sources can help visit nra.org or write to the following address:

National Rifle Association
11250 Waples Mill Road
Fairfax, VA 22030-7400

The person possessing a firearm has a full-time job. You cannot guess; You cannot forget; You must know how to use your firearm safely. **Do not use any firearm without having a complete understanding of its particular characteristics and safe use.** Remember: There is no such thing as a foolproof firearm.

TABLE OF CONTENTS

	Page
State-By-State Warnings	3
Nomenclature	9
Locking Device Installation Instructions	10
General Information	13
Operation of Safety	15
The Bolt Lock	16
10/22 Takedown® Barrel Assembly Instructions	17
Ammunition	19
Special Safety Note - 10/22® Target Rifle Only	20
Magazine	21
Loading the Magazine	21
To Load and Fire (With Magazine)	22
To Load and Fire (Without Magazine)	24
To Unload	24
To Extract and Eject a Chambered Cartridge	26
To Clear a Malfunction (“Jam”)	26
To Minimize Malfunctions (“Jams”)	27
Disassembly	29
Reassembly	30
Check Your Rifle’s Function	31
Magazine Inspection and Care	32
Care and Cleaning	33
Storage	34
Maintenance of Stainless Steel Rifles	35
Attaching Scope Base Adapter	35
Sight Adjustment	36
Service and Parts Policy	37
Shipping Firearms for Repair	37
Ordering Parts	38
Parts Lists	39
Exploded Views	41 - 44
10/22 Takedown® Supplemental Parts List & Exploded View	44 & 45
The Basic Rules of Safe Firearms Handling	46
Warranty Information	52

“RUGER” and “10/22” are registered U.S. trademarks.



WARNINGS OF GREAT IMPORTANCE ARE FOUND ON THE FOLLOWING PAGES:

Locking Devices	10	Handling	23
Alterations	13	Unloading	24
Manual Safety	16	Malfunctions	28
Lead Exposure	19	Disassembly	28
Ammunition	19	Lubrication	33
“Stinger” Ammunition	20	Storage	34
Target Trigger	20	Shipping	37
Firing	23	Parts Purchasers	38

OTHER CAUTIONS AND WARNINGS APPEAR THROUGHOUT THE MANUAL.

All models have the same basic operation mechanism and include the following features with which the firearm user should be thoroughly familiar.

Please Note: Some 10/22[®] RIFLES do not have a barrel band.

NOMENCLATURE (10/22[®] CARBINE MODEL SHOWN)

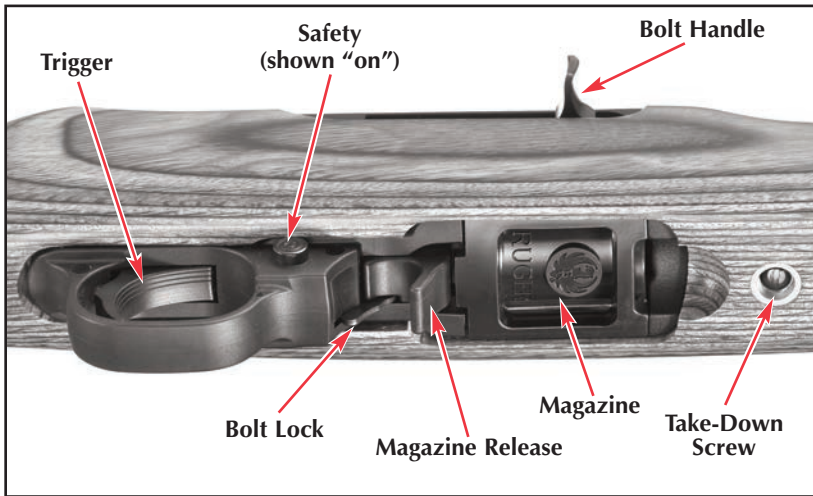
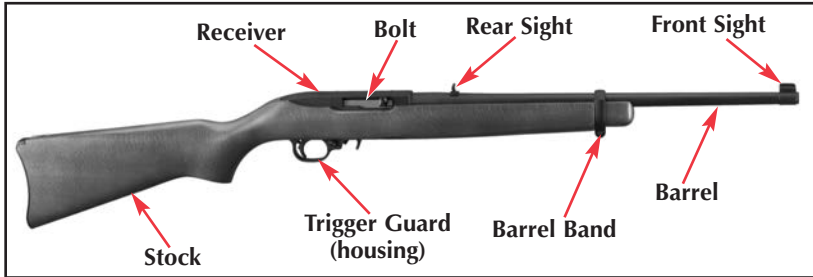

Figure 1. In these illustrations the frequently used operating components are identified. Note that the safety is protruding fully from the right side of the trigger guard and is therefore in its "on" (safe) position.

LOCKING DEVICE INSTALLATION INSTRUCTIONS



WARNING – USE OF LOCKING DEVICES



**Do not store keys
in lock.**

- Always keep your firearm pointed in a safe direction, including when you are installing or removing your locking device.
- Always verify that your firearm is completely **unloaded** before installing your locking device.
- Do **not** install locking devices in the trigger guard; always keep your fingers and locking device outside the trigger guard during device installation and removal.
- Store firearms, ammunition and keys separately and securely, away from children and careless adults; do **not** store your firearm with the keys in the locking device.
- Do not attempt to work the action of your firearm with the locking device in place; this may damage your firearm.
- While locking devices are an important aid to security measures, they are not a substitute for safe firearm handling and proper storage. Remember that any mechanical device can be bypassed with enough time, knowledge, determination and equipment.

**LOCKING DEVICES MUST BE USED
SAFELY AND RESPONSIBLY**

It is important to use the locking device on your Ruger® firearm when the firearm is stored or immediate use is not planned.

Keep the muzzle pointed in a safe direction and your fingers outside the trigger guard at all times!

To Install the Factory-Supplied Locking Device:

1. Remove the magazine.
2. Be sure the firearm and its magazine are completely unloaded and contain no cartridges or cartridge cases!

3. Open the action completely. Use the bolt lock to keep the action open during installation of the locking device.
4. Insert the free end of the cable into the ejection port as shown in Figure 2.
5. Pull the cable through the magazine well as shown in Figure 2.
6. Insert the free end of the cable into the lock. (See Figure 3.)
7. To lock: With the key turned to the farthest clockwise position, insert the loose end of the cable into the lock. Turn the key counterclockwise and remove the key.
8. Once the lock is securely closed, pull firmly on the lock to test the connection and be sure it is locked. **Do not leave or store your firearm with the key in the lock!** Store your locked unloaded firearm and the key in secure, separate locations, away from ammunition, children, and unauthorized adults.

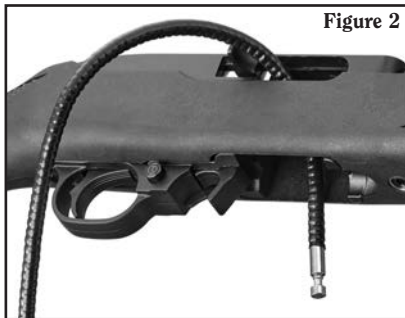

Correct installation of the lock on a Ruger® 10/22® rifle.

To Install the Factory-Supplied Locking Device on the Ruger® 10/22 Takedown® Rifles:

It is important to use the locking device on your Ruger® firearm when the firearm is stored or immediate use is not planned.

Keep the muzzle pointed in a safe direction and your fingers outside the trigger guard at all times!

1. Remove the magazine. Be sure the firearm and its magazine are completely unloaded and contain no cartridges or cartridge cases!
2. Open the action completely. Use the bolt lock to keep the action open during installation of the locking device.
3. Insert the cable directly into your rifle as shown in Figure 4.
4. To lock: With the key turned to the farthest clockwise position, insert the loose end of the cable into the lock. Turn the key counterclockwise and remove the key.
5. Once the lock is securely closed, pull firmly on the lock to test the connection and be sure it is locked. **Do not leave or store your firearm with the key in the lock!** Store your locked unloaded firearm and the key in secure, separate locations, away from ammunition, children, and unauthorized adults.



Correct installation of the lock on a Ruger® 10/22 Takedown® rifle.

**FIREARMS ARE DANGEROUS WEAPON.
READ THE INSTRUCTIONS AND WARNINGS IN THIS
MANUAL THOROUGHLY AND CAREFULLY BEFORE USING.**

 WARNING - ALTERATIONS	
	This product was designed to function properly in its original condition. Alterations can make it unsafe. Do not alter any part or add or substitute parts or accessories not made by Sturm, Ruger & Co., Inc.
	DO NOT ALTER ANY FIREARM

GENERAL INFORMATION AND MECHANICAL CHARACTERISTICS

The RUGER® 10/22® rifles are autoloading, recoil operated rifles.

Retracting the bolt handle cocks the internal hammer and compresses the recoil spring. When the bolt is manually released, it moves forward (driven by the recoil spring), strips a cartridge from the magazine, if a loaded magazine is in place, and chambers the cartridge. The bolt is held against the chambered cartridge by the recoil spring.

When the trigger is pulled, the hammer is released and strikes the firing pin. The firing pin indents the cartridge case rim and ignites the priming compound inside the rim. This ignites the powder in the cartridge case and a great volume of gas is instantly generated, which acts on the interior of the cartridge case in all directions.

Because the bullet offers the least resistance, it moves out of the cartridge case and exits the muzzle. The bolt then moves rearward automatically, extracting and ejecting the fired cartridge case, and at the same time cocking the hammer and compressing the recoil spring, etc., as described above. Once the trigger is released, the rifle is ready to fire again.

Each time the trigger is pulled and released, the same cycle is repeated until there are no more cartridges in the magazine or in the chamber.

The rifle will fire if there is a cartridge in the chamber and the trigger is pulled, whether or not there is a magazine in place! Removing the magazine does not unload the rifle. Never assume the rifle is unloaded. Visually inspect the chamber and the magazine each time the rifle is handled to be certain there are no cartridges in either.

The 10/22® CARBINE is identified by its curved carbine-style butt plate and barrel band. The DELUXE SPORTER MODEL has a flat recoil pad, cut checkered stock, and no barrel band. The TARGET MODEL has a heavyweight, hammer forged barrel, laminated target style stock, and a special target trigger (see p. 20). The ALL-WEATHER® MODEL has a carbine style stock with barrel band and is checkered on the forearm, pistol grip and butt plate. The black composite stock is made of a thermoplastic polyester resin, reinforced with fiberglass for strength, durability, and resistance to the elements. These models use a ten-shot rotary magazine chambered for the 22 Long Rifle cartridge

The 10/22® RIFLE features a slimmer, hardwood stock, longer barrel, flat rifle butt plate, ramp front sight, and no barrel band. It uses the same ten-shot rotary magazine, chambered for the 22 Long Rifle cartridge, as the 10/22® Carbine models.

The 10/22® COMPACT RIFLE features a shorter barrel, shorter rifle-style, hardwood stock and forend, flat buttplate, and fiber optic front and rear sights. Chambered for the 22 Long Rifle Rimfire cartridge, the Compact Rifle uses the same ten-shot rotary magazine as the 10/22® Carbine.

The 10/22® TACTICAL RIFLE features a Mini-14®-style flash suppressor. This threaded barrel version allows owners to attach an assortment of muzzle accessories. It also features a black synthetic stock, and a precision-rifled, cold hammer-forged 16-1/8" alloy steel barrel with black matte finish. This model uses the same ten-shot rotary magazine as the 10/22® Carbine.

The RUGER® 10/22 TAKEDOWN® RIFLE features an easy takedown for quick separation of the barrel from the action for ease of transportation and storage. Simple reassembly allows for a secure connection of the barrel and action and returns the firearm to zero, even when receiver mounted optics are used, ensuring consistent accuracy. See page 17 for "Barrel Assembly Instructions." This model uses the same ten-shot rotary magazine as the 10/22® Carbine.

OPERATION OF SAFETY

The RUGER® 10/22® rifles and carbines have a cross-button safety which is located in the forward portion of the trigger guard (See Figure 1, p. 9.) The safety can be operated only when the hammer is cocked.

The safety is “on” when it protrudes fully from the right side (the bolt handle side) of the trigger guard assembly, as shown in Figure 1. In this position the sear is blocked, and the firearm cannot be fired from a normal pull on the trigger.

The safety should always be in the “on” (safe) position except when the shooter is actually firing the firearm. The safety should be moved to the “on” position whenever the shooter ceases firing, even temporarily.

The safety is “off” (fire) when it protrudes from the left side of the trigger guard assembly, as shown in Figure 5. When the safety is off, the red band shows on the safety button. Do not totally rely on the appearance of the red band to indicate that the safety is off. In poor light or if dirt is present, the red band may not be visible. **If the safety is “off” and the trigger is pulled, the rifle will fire.**

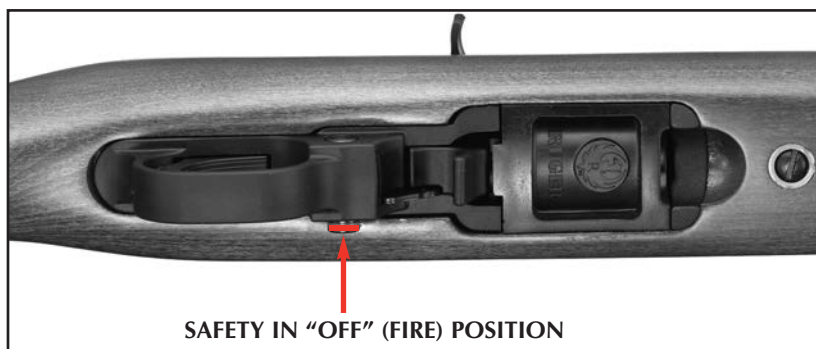
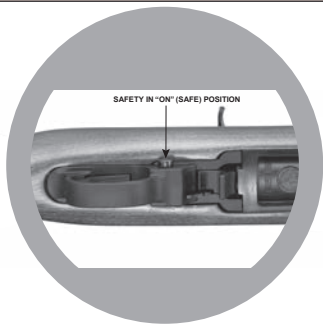

Figure 5. The underside of the trigger guard section of the rifle. In this illustration the safety is shown in the “off” (fire) position. The position of the safety and red band indicate the safety is “off.” **It should be in this position only when you are actually firing at a target.**

The safety is held in its “on” or “off” position by a plunger that is under spring tension. When the safety is moved to either the “on” or “off” position, a distinct “click” should be heard. Frequently check the position of the safety to be certain the safety has not been inadvertently moved. If the safety seems to move too easily, or if the click is not heard when the safety is moved, stop using the rifle and return it to the Newport Customer Service Department for repair (see p. 37).



WARNING – MANUAL SAFETY



Keep the safety on unless actually firing. Always move the safety fully to its intended position and check it. The safety is not “ON” unless it is completely “ON”. Never depend on a safety mechanism or any other mechanical device to justify careless handling or permitting the rifle to point in an unsafe direction. The only “safe” rifle is one in which the bolt is open, the chamber is empty, and there is no magazine in the firearm.

KNOW HOW TO USE THE SAFETY

THE BOLT LOCK

The bolt lock is located in the forward section of the trigger guard (see Figure 1, p. 9). The bolt lock is the manually operated means of retaining the bolt in the rearward (open) position. When the bolt is locked open, the rifle is in an inoperative safe condition for inspection of the chamber, cleaning, etc.

To lock the bolt open: Retract the bolt handle to its extreme rearward position and, while holding it there, press in on the lower section of the bolt lock. Release pressure on the bolt handle and it will move forward a fraction of an inch, and then be locked in its open position.

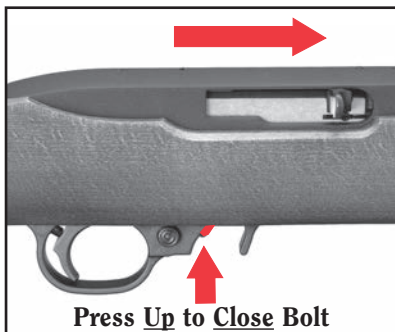
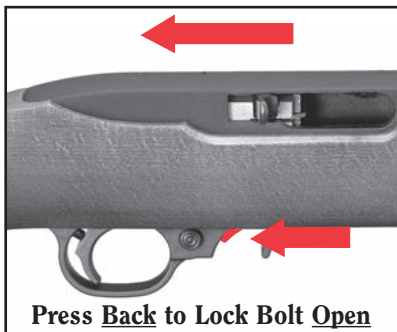

To release the bolt: Retract the bolt handle to its extreme rearward position and then press in on the upper section of the bolt lock. Release the bolt and it will move fully forward.

NOTE: Simply retracting the bolt will not disengage the lock. The bolt lock must be deliberately pressed up while the bolt is held fully to the rear. Only then will the bolt close when released. This is designed to prevent accidental release of the bolt from its open position.

RUGER® 10/22 TAKEDOWN®

BARREL ASSEMBLY INSTRUCTIONS

The RUGER® 10/22 TAKEDOWN® rifle has an adjustable lock-up mechanism. The following directions describe the adjustment necessary to ensure proper lockup the first time the barrel is installed. After the first adjustment, the barrel may be installed by following steps 1 and 3 **only**, and the barrel may be removed by following steps 1 and 5 **only**.

1. Remove the magazine, lock the bolt open (see page 16), and verify the rifle is unloaded by visually inspecting the chamber.
2. Loosen the adjustment knob by turning it **clockwise** as far as possible with finger pressure. (See Figures 6a & 6b.)

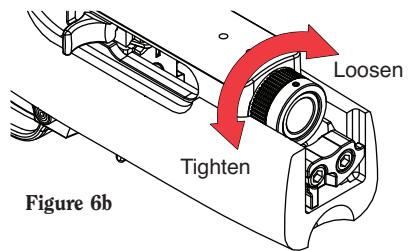
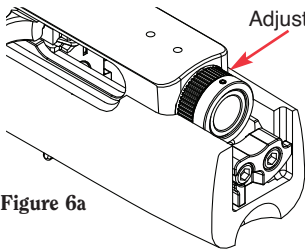

INSTALLING THE BARREL ASSEMBLY

3. Install the barrel assembly by:

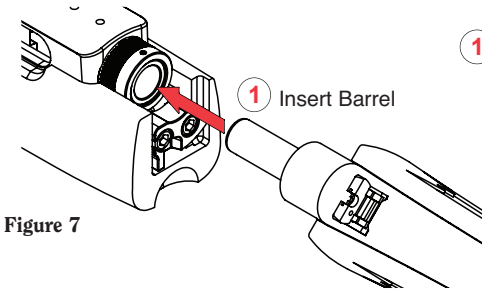

- 1 inserting it into the receiver (see Figure 7), and

- 2 rotating it **clockwise** until it locks into place. (See Figure 8.)

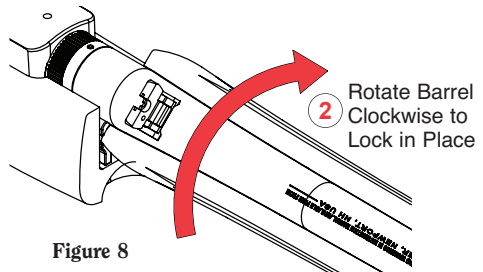

4. Tighten the adjustment knob by turning it **counterclockwise** as far as possible with finger pressure.
5. To remove the barrel assembly, (1) lock the bolt back and (2) push the locking lever towards the muzzle. Next, (3) rotate the barrel assembly **counterclockwise** and (4) pull the barrel assembly out of the receiver. (See Figure 9.)

REMOVING THE BARREL ASSEMBLY

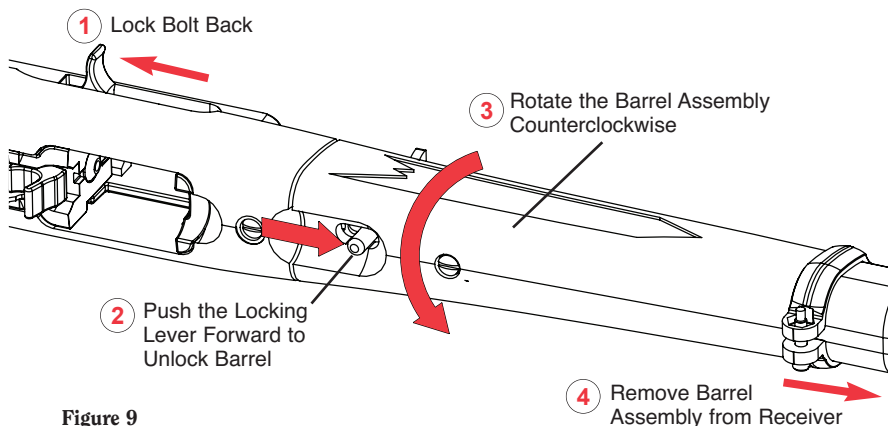

Figure 9



6. Tighten the adjustment knob by rotating it counterclockwise one or two (1 - 2) more clicks.
7. Reinstall the barrel assembly. You should feel some resistance when turning the barrel assembly, but it should not be difficult. If further adjustment is needed, remove the barrel assembly and “tighten” or “loosen” the adjustment knob accordingly.



NOTE: Following barrel installation, best fired shot accuracy will be achieved if the action is dry cycled prior to actually firing ammunition in the rifle: Remove the magazine from the rifle and be certain the chamber is empty. Keeping the rifle pointed in a safe direction, pull the bolt handle fully to the rear while holding the bolt lock up, then release the bolt handle, letting it “slingshot” (freely fly forward) into the ready-to-fire position. Repeat 2 - 3 times. This will properly “seat” the barrel assembly.

AMMUNITION

The RUGER® 10/22® CARBINE and 10/22® RIFLES are chambered for, and designed to properly function with, only the 22 caliber Long Rifle rimfire cartridge, standard, high velocity, or hyper-velocity, manufactured to U.S. industry standards.

Do not use 22 short, 22 long, 22 shot, or 22 cartridges loaded with blunt-nosed, sharp-shouldered, or “explosive” bullets. They will not function reliably and may jam the mechanism or discharge before being fully chambered. Use only ammunition that functions correctly in your rifle. See “Warning – Malfunctions,” p. 28.



		WARNING - LEAD EXPOSURE
	Discharging firearms in poorly ventilated areas, cleaning firearms, or handling ammunition may result in exposure to lead and other substances known to the State of California to cause birth defects, reproductive harm, and other serious physical injury. Have adequate ventilation at all times. Wash hands thoroughly after exposure.	
	SHOOTING OR CLEANING FIREARMS MAY EXPOSE YOU TO LEAD	

		WARNING – AMMUNITION
	Use only new, factory ammunition of the correct caliber. Death, serious injury, and damage can result from the wrong ammunition, bore obstructions, powder overloads or incorrect cartridge components. 22 cases are very thin and sometimes split when fired.	
		<u>Always</u> wear shooting glasses and hearing protection.
		IMPROPER AMMUNITION DESTROYS FIREARMS

AMMUNITION (CARTRIDGES) NOTICE

WE SPECIFICALLY DISCLAIM RESPONSIBILITY FOR ANY DAMAGE OR INJURY WHATSOEVER OCCURRING IN CONNECTION WITH, OR AS A RESULT OF, THE USE IN ANY RUGER FIREARMS OF FAULTY OR NON-STANDARD OR “REMANUFACTURED” OR HAND-LOADED (RELOADED) AMMUNITION OR OF CARTRIDGES OTHER THAN THOSE FOR WHICH THE FIREARM WAS ORIGINALLY CHAMBERED.



NOTE: The following warning applies to RUGER® 10/22® TARGET and TACTICAL rifles only:

 WARNING – “STINGER” AMMUNITION	
 <p>22 LR 22 "Stinger"</p>	<p>“Stinger” cartridges have a longer case than 22 LR cartridges loaded to U.S. Industry specifications. They can stick in the tighter chambers of target rifles, including the Ruger® 10/22® Target and Tactical rifles, which can result in a hazardous ruptured case and release of hot powder gasses and brass when fired.</p>
DO NOT USE “STINGER” AMMUNITION IN 10/22® TARGET or TACTICAL RIFLES	

SPECIAL SAFETY NOTE 10/22® TARGET RIFLE ONLY

The special model you have selected is specifically designed for rapid fire precision target shooting. As such, it demands that you take extra safety precautions.

The trigger of the Target version of the RUGER® 10/22® has a lighter, target trigger pull than standard 10/22® rifles and carbines, for more precise placement of shots. You should practice “dry-firing” an empty rifle (with it pointing in a safe direction) to learn the “feel” of the trigger before ever loading it with ammunition.

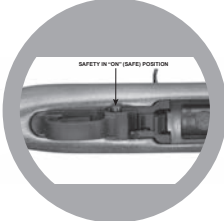
 WARNING – TARGET TRIGGER	
	<p>10/22® Target models have a target trigger that has been carefully set at the factory to a minimum safe weight of pull for precision target shooting. Do not alter any factory setting! You can create an unsafe condition and the rifle may fire unexpectedly.</p>
	<p>You should be especially careful to keep the safety on at all times except when actually firing and keep your finger off the trigger unless you are squeezing it to fire, in order to minimize the possibility of accidental discharge.</p>
DO NOT TAMPER WITH TRIGGER - KEEP SAFETY ON UNLESS FIRING	

MAGAZINE

The 9-shot 22 WMR magazine (JMX-1) for the Ruger® 10/22® Magnum is longer than the 10-shot 22 long rifle magazine (BX-1) for Ruger® 10/22® rifles. Do not attempt to use standard 10/22 magazines in the 10/22® Magnum rifles or load 22 short, long, or long rifle ammunition into the 22 magnum. They will not function correctly and are unsafe to use in 22 magnum rifles.

Ruger 10/22® Magnum Magazine (JMX-1)

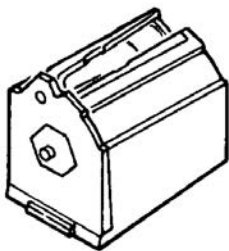

Ruger 10/22® Long Rifle Magazine (BX-1)

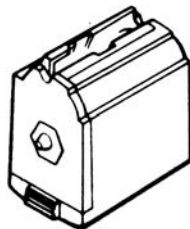

Do Not Use in Ruger® 10/22® Magnum

Never attempt to use 22 Long Rifle ammunition in Ruger® 10/22® Magnum rifle magazines. The cartridges have a smaller case diameter and can split or burst when fired in the larger magnum chamber, releasing hot powder gasses and particle fragments out of the action at high speed, possibly resulting in injury to the shooter or bystanders.

LOADING THE MAGAZINE

To load the magazine, press the rim of the cartridge against the magazine rotor at the widest section of the magazine throat until the cartridge enters far enough to be pushed to the rear end of the magazine. Each succeeding cartridge is pressed against the body of the top cartridge and slid to the rear of the magazine until a maximum of ten (10) 22 LR cartridges are in the magazine.

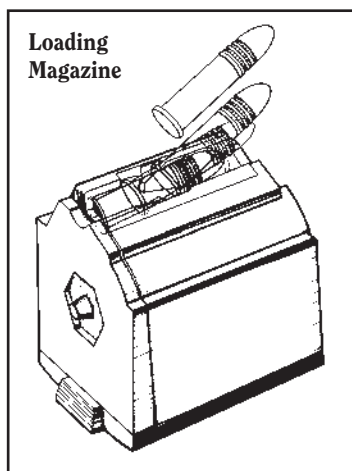

TO LOAD AND FIRE (WITH MAGAZINE)

Practice this important aspect of firearm handling (with an unloaded rifle) until you can perform each of the steps – described below – with skill and confidence. But before you do anything with the rifle, please first read completely through this manual.

1. **Keep the muzzle pointed in a safe direction.** (See Rule 2, p. 46.)
2. Pull the bolt handle rearward. Engage the bolt lock so that the bolt is held open. (See p. 16.) Check the chamber to be certain it is empty. Engage the safety. (See Figure 1, p. 9.)

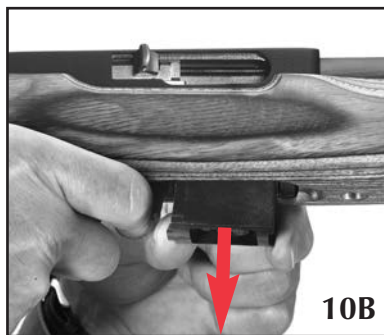
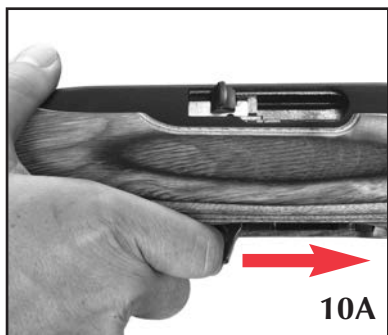

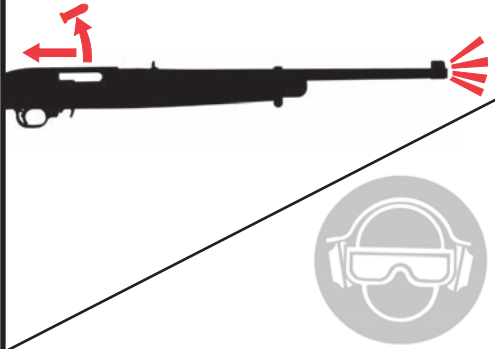

Figure 10. The safety should be “on” when the magazine is being removed or inserted. Move the magazine release forward (Figure 10A) and draw the magazine out by grasping it between your thumb and forefinger and draw it out of the firearm (Figure 10B).

3. Remove the magazine by using your index finger to push forward on the magazine release (Figure 10A) and at the same time grasp the magazine between thumb and forefinger of the other hand to draw it out of the magazine well. (See Figure 10B.)
4. Load the magazine with the appropriate number of cartridges (see “Loading The Magazine” section, p. 21).
5. Insert magazine into the firearm, with bullet end of the cartridges toward the muzzle. (Magazine cannot be seated if reversed.)
6. Load a cartridge into the chamber by fully retracting the bolt handle, releasing the bolt lock, and then releasing the bolt handle. **Don't touch the trigger.** Do not ‘ride’ the bolt handle as it moves forward. Do not apply force to the bolt handle to chamber a cartridge. If a cartridge does not readily chamber, eject it from the rifle, lock the bolt open, remove the magazine and see “Warning – Malfunctions”, p. 28.
7. The rifle is now fully loaded. **If the rifle is not to be fired immediately, the safety should remain “ON”.** (See Figure 1, p. 9.) When the safety is moved to the “off” position, the rifle will fire each time the trigger is pulled until all the cartridges in the magazine, and the one in the chamber, have been fired. Firing will automatically reload and recock the rifle. **Note that every time the trigger is pulled, if a cartridge is in the chamber, the rifle will fire – be careful!**
8. **Immediately following the firing of a shot, and if a subsequent shot is not to be fired at once, put the safety “ON” while the rifle is still pointing in a safe direction down range.**

The safety should be moved to the “on” position as soon as firing is completed, and it should be “on” at all times except when the rifle is on target and being fired.

9. The bolt does not remain open after the last shot has been fired, nor does the bolt automatically lock open when the magazine is empty. When firing is completed, manually retract the bolt, lock it open, and visually check the chamber to be sure it is empty. **If the bolt is shut, the shooter should always assume that there is a cartridge in the chamber. Don't rely on your memory to know if a firearm or magazine is loaded. Visually inspect the magazine and the chamber.**

 WARNING – FIRING	
	<p>The bolt automatically opens and shuts quickly while firing. Keep face and hands away from it. Hot brass and powder gas are ejected quickly and can burn you. The rifle should be fired from the right shoulder. Always wear shooting glasses and hearing protection.</p>
BOLT OPENS FAST – HOT BRASS EJECTED	

 WARNING – HANDLING	
	<p>If dropped or struck with the safety “off”, the rifle may fire. Keep chamber empty unless actually firing! Keep safety “on” unless actually firing!</p>
ANY FIREARM MAY FIRE IF DROPPED	

TO LOAD AND FIRE (WITHOUT MAGAZINE)

The rifle can be used as a single-shot rifle in the absence of a magazine or for safety or training purposes. To do so, follow steps 1 through 3, p. 22. Next, carefully place a single cartridge into the chamber. The chamber can be accessed either through the magazine well or ejection port. Retract the bolt handle, release the bolt lock, and then release the bolt handle. The rifle is now loaded. Follow the additional instructions beginning at Step 7 on p. 22.

 WARNING – UNLOADING	
	So that the rifle can be used as a single loader, it will fire whether or not a magazine is in the firearm if a cartridge is chambered. Removing magazine does not unload rifle! To unload, first remove magazine, then pull bolt to rear, eject chambered cartridge, and visually inspect chamber. The safety should always be in the “on” (safe) position when loading or unloading the rifle. Keep safety “on”.
	FIREARM WILL FIRE WITH MAGAZINE OUT

TO UNLOAD

(RIFLE MUST BE KEPT POINTED IN A SAFE DIRECTION)

UNLOAD THE RIFLE IMMEDIATELY WHEN YOU ARE FINISHED SHOOTING!

NOTE: This sequence must be followed exactly as spelled out. Failure to do so can result in the rifle’s chamber becoming unintentionally loaded with a cartridge!

1. Keep the muzzle pointed in a safe direction at all times and keep fingers outside the trigger guard. If the rifle is cocked, **move the safety to the “on” position.**
2. Remove the magazine. **Remember that even though the magazine has been removed, a cartridge remaining in the chamber can still be fired!**
3. Retract the bolt to its open position and lock it there. This should eject any cartridge in the chamber, but...
4. **Always visually double check the chamber to be certain it is empty.**
5. The only “safe” rifle is one in which the bolt is open and the chamber and magazine are empty.

6. Cartridges can be removed from the magazine by simply pushing them lightly downward and forward with the thumb, forefinger, or the rubber eraser end of a pencil against the rim of the top cartridge. **Do not use a loaded cartridge as a 'tool' to strip cartridges from the magazine.**
7. If desired, the bolt can be left in the open position, being held there by the bolt lock. If it is desired to close the bolt, again look to be certain the chamber is empty. Put the safety "on", retract the bolt to its rearmost position, release the bolt lock and let the bolt snap forward. Keep your fingers out of the receiver!
8. **With the muzzle pointed in a safe direction,** push the safety to the "off" position and pull the trigger to decock it. The rifle can be "dry fired" for practice as long as it is empty and pointed in a safe direction.
9. Push empty (unloaded) magazine into the rifle until the catch locks it in place.

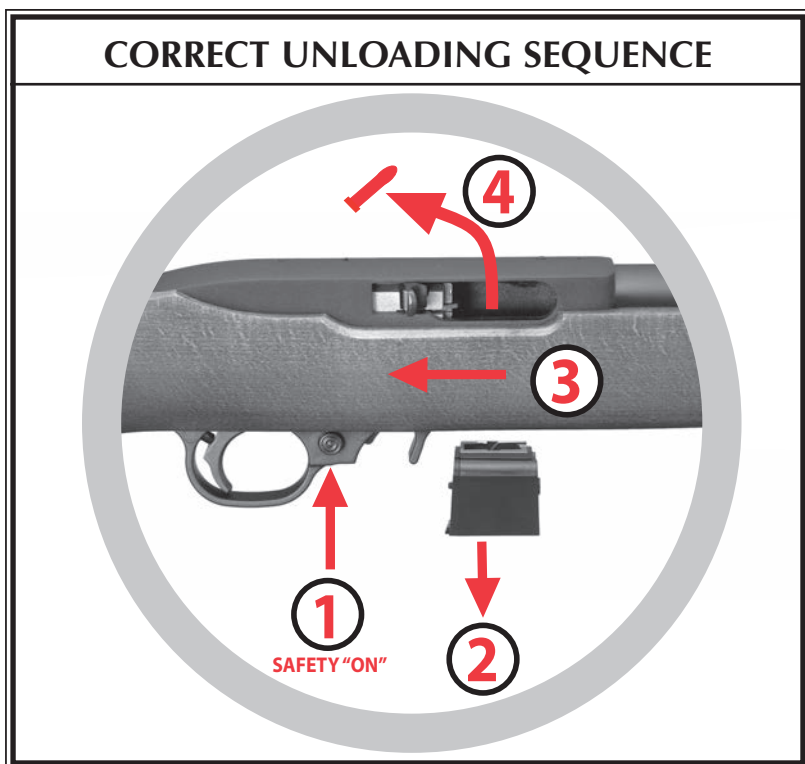

TO EXTRACT AND EJECT A CHAMBERED CARTRIDGE

When the rifle is fired, the same gas pressure which drives the bullet forward also acts through the cartridge case to push the bolt to the rear. That action causes extraction and ejection of the fired cartridge case. But, when the bolt is operated by hand, there can be a failure to extract the cartridge from the chamber, or a failure to eject the cartridge clear of the rifle. These failures usually are the result of the bolt not being pulled rearward vigorously, coupled with an accumulation of bullet lubricant in the chamber. From the foregoing it is clear that the firearm user must:

1. **Always visually check the chamber after opening the bolt to eject a chambered cartridge.** If the bolt is not vigorously retracted when being operated by hand, the extracted cartridge can be 'ejected' into the magazine area, instead of outside the rifle.
2. Thoroughly clean the chamber and the extractor as often as necessary to prevent the accumulation of grease and dirt.
3. If an empty magazine is in the rifle when the bolt is being hand retracted to extract a cartridge, the cartridge may drop on top of the magazine. Then when the bolt goes forward, the cartridge will be chambered again! **Always remove the magazine before clearing the chamber, and visually ensure that no cartridges remain in the firearm.**

TO CLEAR A MALFUNCTION ("JAM")

Any autoloading firearm may occasionally malfunction. If it does:

1. **Be certain the muzzle is pointed in a safe direction and the safety is "on."**
2. If possible, first remove the magazine. It may be necessary to manually remove a jammed cartridge which has only partially been stripped from the magazine.

If so, use extreme care. Lock the bolt open with the bolt stop before attempting to clear the jam. Drawing the bolt fully to the rear may bring the jammed cartridge along. **Keep your face away from the ejection port during this operation.** When attempting to clear a jam, use only wood 'tools' so that a cartridge will not be ignited if you strike a primer, and so that the chamber and magazine will not be damaged. A 3/16" wood dowel rod with a point on one end is useful.

3. Visually check to make sure all cartridges have been removed from the rifle. Safely dispose of any cartridges involved in a malfunction incident. Do not use damaged ammunition in any firearm.

TO MINIMIZE MALFUNCTIONS ("JAMS")

Most malfunctions are caused by improper or damaged magazines, incorrect ammunition, or poor maintenance.

1. If it appears that the firearm and magazine are not at fault and that the jam was caused by the type of cartridge being used, then try another type.
2. If changing to another type or brand of cartridges does not at once eliminate malfunctioning, then the following steps should be taken:
 - a. **Make certain the firearm and the magazine are unloaded and that the safety is "on."** Remember, the magazine should be removed first, then check the chamber and be certain it and the magazine-well are clear of cartridges.
 - b. Thoroughly clean the magazine (See "Magazine Inspection and Care," p. 32) and bolt mechanism, paying particular attention to removing accumulated grease. Use a bristle brush and solvent to remove grease and fouling from the bolt face, the extractor, the chamber, and the feed ramp. (See the "Care and Cleaning" section of this manual for detailed cleaning instructions.)
 - c. Check to see that the magazine rotor spring tension is adequate.
 - d. Check the magazine throat to be certain they are free of nicks and burrs and are not deformed.
 - e. Remove excess oil and solvent from all cleaned components, load the magazine, and try the firearm again. As always, proceed slowly. **Be certain bystanders are not close and that you are wearing eye and hearing protection and that your face is a safe distance from the rifle so that any discharge resulting from a jammed cartridge will not injure anyone.**

If the above procedures do not result in a smooth and reliably functioning firearm, don't use the firearm. The rifle can be returned directly to our Newport, New Hampshire Customer Service Department for repair. See the Service and Parts Policy section (p. 37) of this manual for packing and shipping information.

Another precaution: When using any firearm chambered for rimfire cartridges, form the habit of examining fired cartridge cases. If they have bulged heads or frequently show splits on any part of the case, the rifle or pistol should be returned to the factory for inspection.



WARNING – MALFUNCTIONS



The 22 Long Rifle rimfire cartridges fire when the firing pin impacts the relatively soft cartridge case rim, and also can be “discharged” before it is chambered if its rim receives a sharp blow. If a cartridge hangs up, jams, or binds when being chambered or when being fed from the magazine into the chamber, **do not attempt to force it into the chamber by pushing or striking the bolt.** Any jam or feeding problem is a signal to immediately stop using the firearm until it can be determined what is wrong. Most failures of a cartridge to feed or to chamber are caused by a damaged magazine, improper firearm handling, poor maintenance, improper or defective ammunition. **Whatever the cause, rimfire cartridge jams can result in the potentially very dangerous situation of a cartridge discharging before it is chambered. If this occurs, the cartridge case will rupture and its fragments will fly out of the firearm with sufficient force to cause injury. Always wear shooting glasses and hearing protectors! Keep face away from chamber!**



CRUSHING RIM CAN BURST AMMO



WARNING – DISASSEMBLY

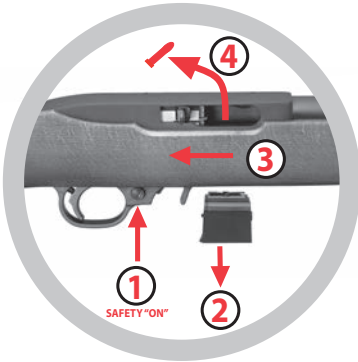

Always unload a firearm before cleaning, lubrication, disassembly or assembly.

**UNLOAD BEFORE
CLEANING**

DISASSEMBLY

BE SURE RIFLE IS UNLOADED!

An on-line video demonstrating the disassembly and reassembly of the 10/22® rifles can be viewed by going to **Ruger.com/TechTips**.

1. **With the rifle pointing in a safe direction, remove the magazine, open the bolt and visually make certain there is not a cartridge in the chamber.** Then allow the bolt to close. The rear sight leaf should be down, and the hammer should be cocked.
2. Loosen the barrel band screw and remove the barrel band. (Does not apply to non-barrel band models such as the Sporter and Rifle Model.)
3. Use an appropriate size Allen wrench to loosen (don't remove) the take-down screw.
4. Position the safety so an equal amount of the button is exposed on each side. If the safety is not in the middle when the barrel-receiver assembly is lifted out of the stock, the stock will be damaged.
5. Swing the barrel-receiver assembly upward away from the forearm of the stock. Be careful the two receiver cross pins and bolt stop pin do not fall out.
6. Place the safety in the "ON" position. Remove the trigger guard by simply drifting out the two receiver pins. It is recommended that the components of the trigger guard assembly not be disassembled from the trigger guard.

This is the extent of disassembly required for routine inspection, cleaning and lubrication.

If it is desired to thoroughly clean the inside of the receiver by removing the bolt, be aware that although removing and installing the bolt (along with the bolt handle-recoil spring assembly) is simple, it must be done correctly.

7. To remove the bolt:

- a. Position the rifle upside down so the bolt is fully accessible.
- b. Drift out the bolt stop pin, located at the rear of the receiver.
- c. Pull the bolt handle fully to the rear of the receiver with the left hand, and while it is in that position, using the right hand, lift up the front of the bolt until it is disengaged from the bolt handle.
- d. Remove the bolt handle assembly through the ejection port.
- e. Lift bolt out of receiver. If it does not come out readily, turn the rifle over and the bolt will drop out of the receiver.

REASSEMBLY

AGAIN, BE SURE RIFLE IS UNLOADED!

1. Reassembly of bolt into receiver:

- To reassemble bolt handle and bolt in the receiver, position the rear end (cone pointed) of the recoil spring guide rod in the mating recess near the rear right side of the receiver. The recoil spring must be flat against the side and “bottom” of the receiver.
- Maintain the guide rod in its proper position by keeping pressure on the bolt handle with the left forefinger and thumb. At the same time, use the flat side of the screwdriver blade to compress the recoil spring by drawing it against that area of the bolt handle near to the spring. In accomplishing this spring compression it is necessary to maintain the same pressure on the screwdriver with the right hand as that being maintained (rearward and inward) on the bolt handle with the left hand.
- When the spring is fully compressed, maintain it in that position with the left hand and with the right hand lay the recessed section of the top of the bolt on the section of the bolt handle that mates with it. Press down on the bolt until a ‘click’ is heard. At this point allow the bolt handle (with bolt attached) to move forward slowly.
- Cycle the bolt handle a few times to be certain the components are correctly assembled.

2. Reassembly of rifle:

- Install the bolt stop pin and then lay the trigger guard in place and install the two receiver pins. **NOTE:** Be sure the ejector is held in the ejector slot as you set the trigger guard in place (see Figure 11).
- Assemble the barrel-receiver to the stock by following, in reverse order, steps 1 through 5 under the “Disassembly” instructions on page 29.

Firearms should not be stored loaded or cocked!

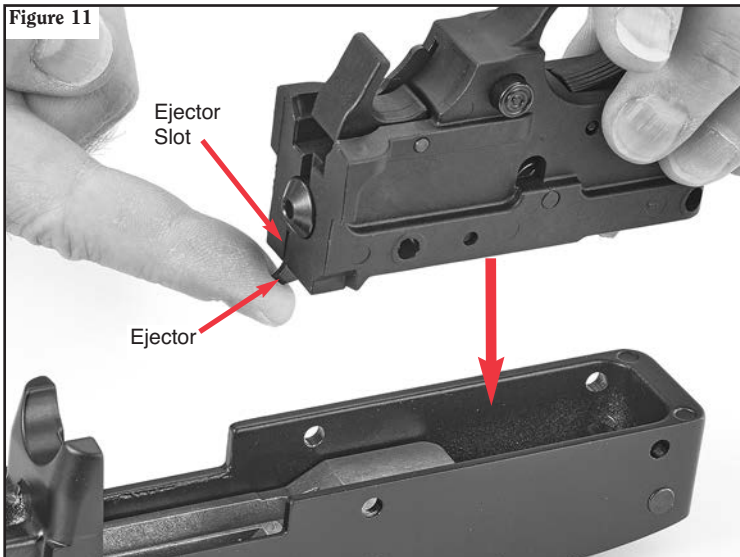

CHECK YOUR RIFLE'S FUNCTION

After any disassembly and reassembly, it is important to verify that the action is working correctly before any live firing is attempted.

FIRST, BE SURE THERE IS NO AMMUNITION IN THE CHAMBER OR THE MAGAZINE AND KEEP THE RIFLE POINTED IN A SAFE DIRECTION!

a. CHECK THE BOLT FUNCTION: Pull the bolt fully to the rear and release it. The bolt should operate smoothly and travel freely within the receiver without binding. Repeat this process two more times.

b. CHECK THE SAFETY FUNCTION: **NOTE:** When the safety is moved to either the “on” or “off” position, a distinct “click” should be heard. If the safety seems to move too easily, or if the click is not heard when the safety is moved, stop using the rifle and contact Ruger Customer Service at 336-949-5200. For additional information regarding the safety, please refer to the “Operation of Safety” section of this manual.

- First, pull the bolt fully to the rear and release it. This should cock the hammer. Do not dry fire the rifle.
- Next, engage the safety by pushing it into the “on” position and attempt to pull the trigger. With the safety in this position, the trigger should not move and the hammer should not fall.
- Finally, move the safety to the “off” position. With the rifle pointed in a safe direction, pull the trigger and listen for an audible “click” as an indication the hammer has fallen, striking the firing pin.

Repeat this process two more times.

c. CHECK THE BOLT LOCK FUNCTION:

- First, retract the bolt handle to its extreme rearward position and, while holding it there, press in on the lower section of the bolt lock.
- Next, release pressure on the bolt handle. The bolt should move forward a fraction of an inch, and then be locked in its open position.
- Finally, retract the bolt handle to its extreme rearward position and then press in on the upper section of the bolt lock. Release the bolt and it should move fully forward.

An on-line video demonstrating the disassembly, reassembly, and function check of the RUGER® 10/22® can be viewed by going to **Ruger.com/TechTips**.

If any of the above function checks fail or if you are uncertain, please consult a competent gunsmith or contact Ruger Customer Service at 336-949-5200 for further firearm inspection before using the rifle.

MAGAZINE INSPECTION AND CARE

Check the magazine frequently. The rotor must move freely and have adequate tension so that each cartridge is quickly raised to the feeding position. At the time of manufacture, proper rotor tension is set by rotating the magazine cap nut until the rotor stops turning. Then the nut is turned an additional 1 1/4 turns beyond the 'stop' position.

To test the rotor tension, load one cartridge into the magazine and then firmly press against the side of the cartridge case. Remove your finger quickly. The cartridge should instantly and fully move in to the feeding position. If it does not, the magazine should be cleaned. **If cleaning does not restore proper rotor tension, do not use the magazine.** (NOTE: After testing, remove the test cartridge.)

When cleaning is necessary, use a solvent that will not rust the metal components or adversely affect the plastic magazine box. After the magazine has been soaked in solvent to loosen foreign matter, be certain to shake it vigorously (with the loading opening away from you) to remove solvent or residue from within the magazine.

After cleaning, always check to be certain that rotor movement and tension are correct, and that no solvent or debris remain. Do not disassemble the magazine. **Improper reassembly or improper tensioning of the rotor spring can cause a potentially dangerous malfunction. If you experience a problem with the magazine, don't use it. Get a new one.**

DAMAGED, NON-STANDARD, OR IMPROPERLY ASSEMBLED MAGAZINES SHOULD NOT BE USED. THEY CAN CAUSE THE RIFLE TO MALFUNCTION.

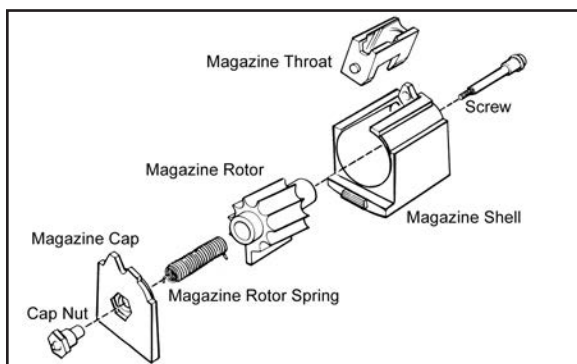

Exploded view of the 10/22[®] magazine components. This illustration is included to show the relationship and names of the magazine components. As noted in the text above, the magazine should not be disassembled.

CARE AND CLEANING

BEFORE CLEANING, BE CERTAIN THE RIFLE AND ITS MAGAZINE ARE UNLOADED.



Cleanliness is most important to the function of this blow-back operated autoloading firearm. Any failures to feed or extract rounds may be indications of a dirty chamber. Use commercially available bore cleaning solution and a brass brush, followed by drying with a cloth patch, to remove any powder residue. **An excess of dirt, powder residue, or oil in the chamber will cause malfunctions and may result in potentially dangerous cartridge case ruptures and release of hot gasses and case fragments when firing.**

At regular intervals, or whenever the rifle has been exposed to sand, dust, extreme humidity, condensation, immersion in water, or other adverse conditions, disassemble, clean and oil it. Proper periodic maintenance is essential to the reliable functioning of any firearm.

An on-line video demonstrating the proper cleaning procedure of the 10/22® rifles can be viewed by going to **Ruger.com/TechTips**.

To clean the rifle, proceed as follows:

1. Disassemble (field-strip) the rifle to the extent described on page 29.
2. Using a cleaning rod, run a properly sized, solvent-wetted patch through the bore several times. Then attach a solvent-wetted bristle brush to a cleaning rod and run it back and forth the full length of the bore as many times as necessary to remove grease and dirt from the bore and chamber. Clean bore with dry patches and examine. Bore fouling can contribute to reduced accuracy, and grease accumulation in the chamber can interfere with proper feeding of cartridges from the magazine.
3. Using powder solvent on a clean patch or bristle brush, remove powder residue from all components of the mechanism. After cleaning, run a dry patch through the bore, then follow with a patch that is very lightly oiled. Wipe all surfaces clean with cloth, then wipe all surfaces with a patch or cloth that has been very lightly oiled.

 WARNING – LUBRICATION	
	Firing a rifle with oil, grease, or any other material even partially obstructing the bore may result in damage to the rifle and serious injury to the shooter and those nearby. Do not spray or apply lubricants directly on ammunition. If the powder of a cartridge is affected by the lubricant, it may not be ignited, but the primer firing may push the bullet into the bore where it may be lodged. Firing a subsequent bullet into the obstructed bore may damage the rifle and cause serious injury or death to the shooter and those nearby. Use lubricants properly. You are responsible for the proper care and maintenance of your firearms.
IMPROPER LUBRICATION DESTROYS FIREARMS	

4. **NOTE:** Only a light application of oil is needed to provide adequate lubrication of moving parts and to prevent rust. Excess accumulations of oil tend to attract particles of dust and dirt and may congeal in cold weather which can interfere with the safe and reliable functioning of the rifle.
5. **Cleaning the Stock:** Use of cleaning solvents containing acetone can damage the finish of your stock, particularly if the stock has a camo-dipped pattern.

STORAGE

FIREARMS SHOULD NOT BE STORED LOADED!

**USE THE LOCKING DEVICE SUPPLIED WITH THE RIFLE
TO RENDER IT INOPERATIVE FOR SAFE STORAGE.**

(SEE PAGE 10)

Do not store the rifle in a leather case or scabbard. Leather attracts moisture, even though it may appear to be dry.

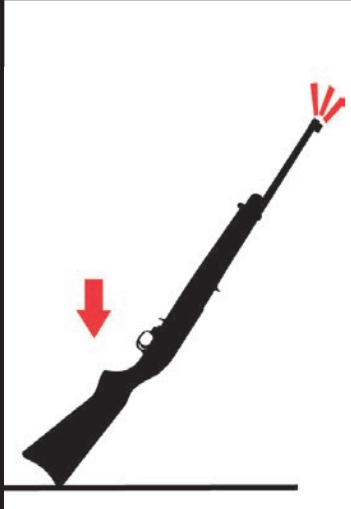
 WARNING – STORAGE	
	<ul style="list-style-type: none">• Never place or store any firearm in such a manner that it may be dislodged. Firearms should always be stored securely and unloaded, away from children and careless adults.• Use the locking device supplied with the rifle for storage. The use of a locking device or safety lock is only one aspect of responsible firearms storage.• For increased safety, firearms should be stored unloaded in a location that is both separate from their ammunition and inaccessible to children and any other unauthorized person.
STORE SECURELY & UNLOADED	

MAINTENANCE OF STAINLESS STEEL RIFLES

Firearms and components made of stainless steel are relatively more resistant to corrosion than those of blued steel. However, in the interest of proper operation and long life of a stainless steel firearm, inspect it frequently and clean, lubricate and apply an appropriate rust preventative.

Sometimes discoloration occurs from perspiration or from contact with some types of firearm cases. Rusting may occur as a result of the firearm being exposed to moisture, salt air or chemicals.

Minor discoloration can usually be removed by rubbing the stainless area with an abrasive ink eraser, crocus cloth, or a “metal polishing” compound. When using any of these abrasives, proceed with care and use light pressure to achieve a blending of “color” with those areas that are not discolored. Do NOT use abrasives on the clear coating of the aluminum alloy receiver and trigger housing.

External surfaces most subject to rusting from handling, or from exposure to the elements, should be cleaned and wiped dry after use or after exposure to adverse conditions. If the rifle is to be stored, coat it with a light film of oil or preservative. Where the rifle is in continuing use, and the presence of oil or grease would be objectionable, then the external surfaces can be coated (after cleaning and drying) with a paste wax formulated for use on metals. Apply the wax sparingly, allow time for it to dry hard, then buff lightly with a soft cloth. When applying the wax, take care that it does not get into the mechanism or on the functioning parts or in the bore.

ATTACHING SCOPE BASE ADAPTER

To attach Scope Base Adapter to rifle receiver:

1. Retract bolt handle, lock bolt open and push safety to “on” position. **Be sure firearm is completely empty.**
2. Unscrew the four filler (headless) screws from the receiver. These screws may be quite tight.
3. Position adapter on receiver and place a base-mounting screw in each hole of the adapter. Turn each screw until it just catches the threads in the receiver hole, but don't tighten the screws at this point.
4. Starting at the first screw, turn each screw part way in; then move to the next screw, repeating the procedure until all four screws are tightened to a maximum torque setting of 12-15 inch/lb.
5. Release the bolt handle; then retract it several times, permitting it to snap forward. If the bolt seems to bind, determine which screw is binding the top of the bolt. If it is necessary to shorten a screw, be certain to chamfer its top so it does not cross thread the hole in the receiver.
6. Attach scope bases and scope to the adapter in accordance with their instructions.

Scope mounting precautions: Do not remove the scope base filler screws (there are four in the receiver) unless the supplied scope base adapter or other suitable base is to be mounted with properly fitting screws. Do not deepen or alter the screw holes that are in the Ruger® 10/22®. **Do not place any thread locker (such as LOCTITE®) into the screw holes in the receiver, as the thread locker can drip into the bolt or receiver and cause potentially dangerous malfunctions.**

**Tip-Off Style
Scope Base
Adapter**



**Weaver-Style
Scope Base
Adapter**

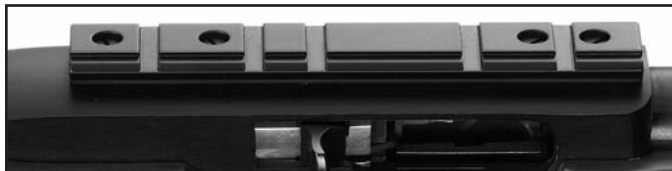

SIGHT ADJUSTMENT

The folding leaf rear sight is adjustable for elevation. The slide must be moved one graduation to change the point of impact by approximately one inch at 25 yards. Use a small screwdriver with a blade tip that exactly fits the screw-head. Loosen the screws only slightly so the slide doesn't move too freely. Move the slide in the direction you want the point of impact of the bullet to move. When the slide is positioned at the desired height, carefully tighten both screws.

Lateral (windage) adjustment is made by 'drifting' the sight base in its slot. Place a short brass rod against the sight base (and only the base) and tap the sight in the direction you wish to move the point of bullet impact. Before moving the sight, pencil mark an index line on the sight base and rib so that sight movement can be detected.

SUGGESTED SIGHT PICTURE

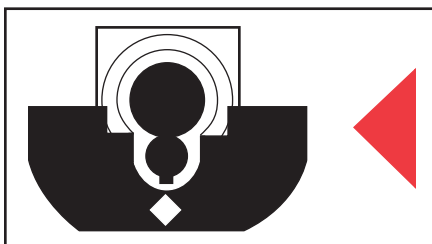

Top of front sight even with top of rear sight slide. Front sight centered in notch of rear sight slide. Target bull's-eye centered on top of front sight.

Note that the rear sight blade can be reversed to give a square notch rear sight picture.

SERVICE AND PARTS POLICY

If you have any question regarding the performance of your RUGER® 10/22® rifle or carbine please contact our Customer Service online at **Ruger.com** or call the Customer Service Dept. at 336-949-5200. Fully describe all circumstances and conditions involved. If you should need to return your revolver to the factory for repair, or order parts for it, please comply with the following suggestions for prompt service:



WARNING: BEFORE SHIPPING ANY FIREARM, BE ABSOLUTELY CERTAIN THAT IT IS UNLOADED. DO NOT SHIP CARTRIDGES WITH A FIREARM.

SHIPPING FIREARMS FOR REPAIR

NOTE: You must obtain a **Repair Authorization Number** before returning your firearm. An authorization number can be obtained by contacting Customer Service online at **Ruger.com** or calling the Customer Service Department at 336-949-5200. Firearms should be sent prepaid. We will not accept collect shipments. Any RUGER® 10/22® rifle returned to the factory for repair should be sent to: Sturm, Ruger & Company, Inc., Customer Service Department, 411 Sunapee Street, Newport, NH 03773.



The Federal Gun Control Act, as well as the laws of most states and localities, do not prohibit an individual (who is not otherwise barred from purchasing or possessing a firearm) from shipping a firearm directly to the manufacturer for repair. However, before you ship your firearm to us, be certain that your state or locality does not have a law or regulation which will prohibit you from receiving the firearm (or any included magazines) from us after repair. If such receipt is prohibited, please have a federally licensed firearms dealer ship the firearm to us. If your firearm is sent to us by a dealer, it will be returned to that dealer after being repaired. If a handgun (pistol or revolver) is shipped by an individual who does not hold a Federal Firearms License, it must be shipped for overnight delivery via U.P.S., Federal Express or other, similar private overnight service.

NOTE: Handguns may not be shipped via U.S. Mail. Persons who do not hold a Federal Firearms License are prohibited by Federal law from shipping a handgun by Mail. Handguns mailed in violation of the law may be impounded or confiscated by the Post Office and the non-FFL may be subject to prosecution. Rifles and shotguns may be shipped via U.S. Mail.

Please do not include rifle case, sling, telescopic sights or custom accessories with a firearm being shipped to the factory for service. **DO NOT SEND FIREARM BOXES OR LITERATURE THAT YOU CONSIDER TO BE COLLECTOR'S ITEMS – THESE ARE INVARIABLY DAMAGED OR DESTROYED IN SHIPMENT.** Always insure your shipment.

Enclose a letter which includes your name, address, telephone number, firearm serial number and model, and repair authorization number. Describe in detail the trouble you have experienced with your firearm, or the work you wish to have done. Merely stating that the firearm “needs repair” is inadequate information. Please enclose copies of any previous correspondence.

All work performed is subject to a minimum labor charge and charges for shipping and handling. Most models can be reblued, but custom gunsmithing service or nonstandard alterations are NOT AVAILABLE from Ruger Customer Service Departments. Please contact the Customer Service Department for pricing information.

 WARNING – PARTS PURCHASERS	
	<ul style="list-style-type: none">• It is the purchaser's responsibility to be absolutely certain that any parts ordered from the factory are correctly fitted and installed.• Firearms are complicated mechanisms and IMPROPER FITTING OF PARTS MAY RESULT IN A DANGEROUS MALFUNCTION, DAMAGE TO THE FIREARM, AND SERIOUS INJURY TO THE SHOOTER AND OTHER PERSONS.• The purchaser and installer of parts must accept full responsibility for the correct adjustment and functioning of the firearm after such installation.
PARTS MUST FIT CORRECTLY	

ORDERING PARTS

Please contact the Newport, New Hampshire Customer Service Department for parts availability and current prices. All parts orders for the **RUGER® 10/22®** rifle should be sent to: Sturm, Ruger & Company, Inc., Customer Service Department, 411 Sunapee Street, Newport, NH, 03773, 336-949-5200.

We cannot comply with open account or C.O.D. requests. Payment in full via credit card (Visa or MasterCard only), money order or certified bank check (no personal checks or cash, please) is required before any service will be performed. Please provide your credit card number, your name as it appears on the credit card, the expiration date, and the 3-digit security code. All parts orders are subject to a minimum charge and charges for shipping and handling. Order parts by **Part Name and specify the model and entire serial number** of the firearm for which the parts are being ordered. There is a minimum labor charge plus a shipping and handling charge if the parts are factory fit. All factory fit parts are fit on an exchange basis only. We will not return the replaced parts. Please contact the Customer Service Department for pricing information.

Because the receiver is a serial numbered component, it is defined as a “firearm” by Federal law and is not sold as a separate component.

*Parts designated by an asterisk must be factory fit. These parts are fit on an exchange basis only. We will not return the replaced parts. We will not return any part that is broken, malfunctioning, badly worn or has been modified. See “Warning — Parts Purchasers,” above..

	WARNING: A firearm containing broken, malfunctioning, or badly worn parts should not be fired.
---	---

RUGER® 10/22® RIFLE

PARTS LIST

Design, prices and specifications subject to change without notice.

SPECIFY MODEL, CALIBER AND SERIAL NO. WHEN ORDERING

(See Exploded View Pages 41 - 43)

Key Part Name

1	Barrel
† 2	Receiver
3	Receiver Cross Pin, 2 Req'd
4	Receiver Filler Screw, 4 Req'd
5	Barrel Retainer V-Block
6	Barrel Retainer Screw, 2 Req'd
7	Bolt Assembly – Complete Includes Key Nos. 8 - 14 (See Exploded View p. 42)
8	Bolt
9	Firing Pin
10	Firing Pin Rebound Spring
11	Firing Pin Stop Pin
12	Extractor
13	Extractor Spring
14	Extractor Plunger
15	Cocking Handle, Guide Rod & Recoil Spring Assembly
16	Trigger Guard Assembly – Complete Includes Key Nos. 17 - 40 (See Exploded View p. 42)
17	Trigger Guard
18	Bolt Lock
19	Bolt Lock Spring
* 20	Hammer
21	Hammer Pivot Pin
22	Hammer Strut
23	Hammer Spring
24	Hammer Strut Washer

* Parts so marked must be factory fit.

† The receiver is a serial-numbered part and is not offered for sale.

Key Part Name

25	Ejector
26	Safety Detent Plunger Spring
27	Safety Detent Plunger
* 28	Safety
29	Disconnecter & Trigger Pivot Pin
30	Disconnecter
31	Sear Spring
* 32	Trigger
* 33	Sear
34	Trigger Pivot Pin
35	Trigger Plunger Spring
36	Trigger Plunger
37	Magazine Latch
38	Magazine Latch Pivot & Ejector Pivot Pin, 2 Req'd
39	Magazine Latch Plunger Spring
40	Magazine Latch Plunger
41	Stock
42	Butt Plate
43	Butt Plate Screw, 2 Req'd
44	Rear Sight
45	Front Sight
46	Bolt Stop Pin
47	Barrel Band
48	Barrel Band Screw
49	Magazine Assembly
50	Scope Base Adapter
51	Scope Base Screws, 4 Req'd
52	Take Down Screw
53	Sling Swivel, Front
54	Sling Swivel, Rear

* Parts so marked must be factory fit.

RUGER® 10/22® CARBINE

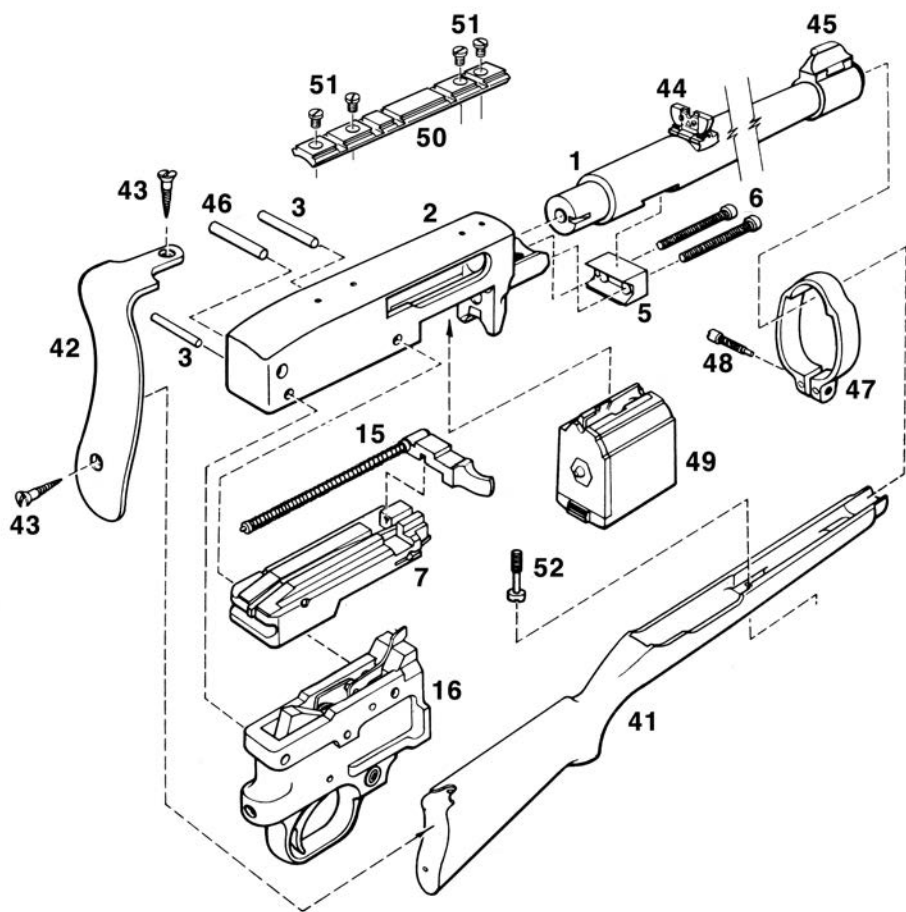

RUGER® 10/22® TACTICAL RIFLE SUPPLEMENTAL PARTS LIST & EXPLODED VIEW

Key Part Name

1	Barrel
55	Washer
56	Flash Hider

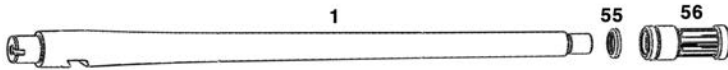

RUGER® 10/22 TAKEDOWN® SUPPLEMENTAL PARTS LIST

(See Exploded View on Page 45)

Key Part Name

1	Barrel
† 2	Receiver
3	Buttstock Assembly
* 4	Insert
5	Detent Spring
6	Safety Detent Plunger
7	Adjusting Knob
8	Spacer
9	Spacer Pin
10	Clamp
11	Barrel Retainer Screws, 2 Req'd
12	Take Down Screw
13	Locking Plunger
14	Locking Plunger Detent
15	Locking Plunger Spring
16	Mounting Screws, 2 Req'd
17	Locking Lever
18	Block
19	Stock – Forend
20	Barrel Band, Black Plastic
21	Barrel Band Screw
22	Barrel Band Retaining Nut

† The receiver is a serial-numbered part and is not offered for sale.

* Parts so marked must be factory fit.

RUGER® 10/22 TAKEDOWN®
SUPPLEMENTAL PARTS EXPLODED VIEW

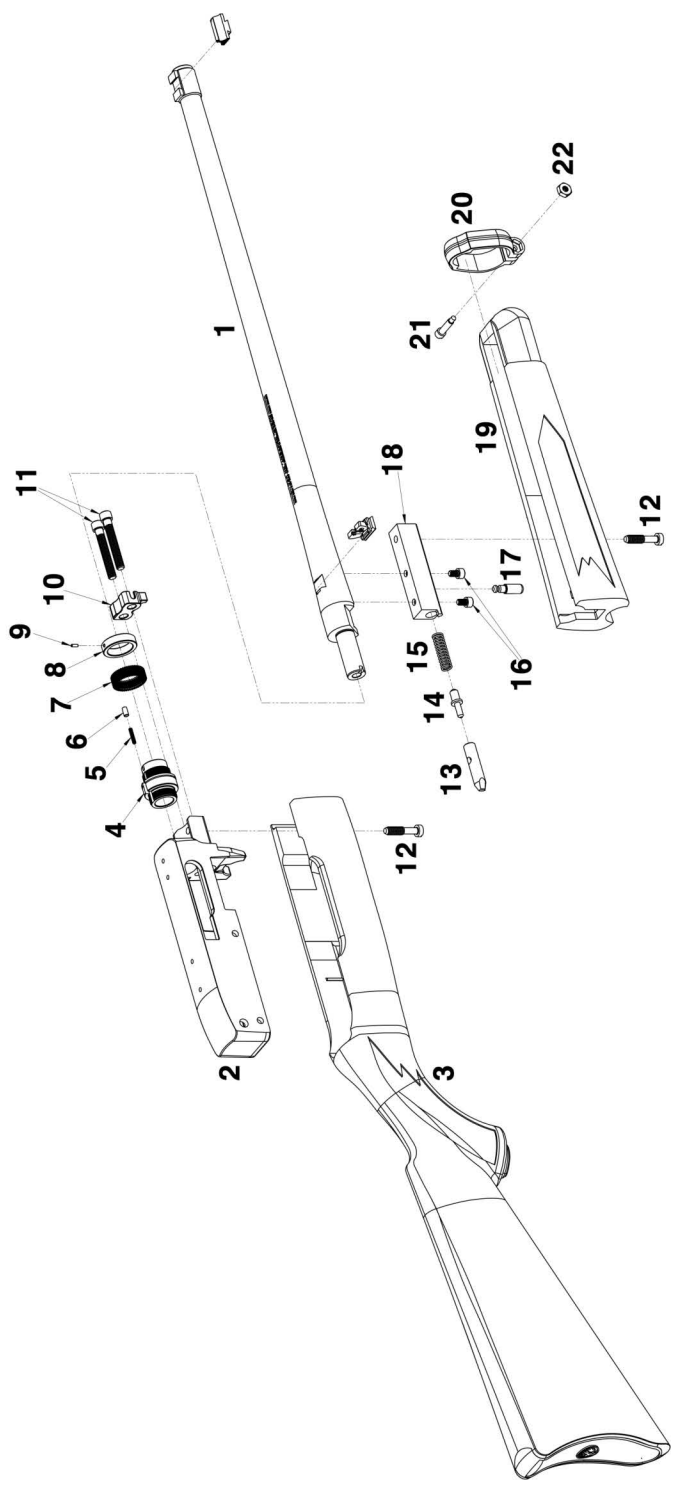

THE BASIC RULES OF SAFE FIREARMS HANDLING

We believe that Americans have a right to purchase and use firearms for lawful purposes. The private ownership of firearms in America is traditional, but that ownership imposes the responsibility on the gun owner to use his firearms in a way which will ensure his own safety and that of others. When firearms are used in a safe and responsible manner, they are a great source of pleasure and satisfaction, and represent a fundamental part of our personal liberty.

Firearms do not cause accidents! Firearms accidents are almost always found to have been the result of carelessness or ignorance on the part of the shooter of the basic rules of safe gun handling.

The following rules must be observed by gun users at all times. Safe gun handling is not just desirable, it is absolutely essential to your safety, the safety of others, and the continuation of gun ownership and sport shooting as we know it today.

1. LEARN THE MECHANICAL AND HANDLING CHARACTERISTICS OF THE FIREARM YOU ARE USING.



Not all firearms are the same. The method of carrying and handling firearms varies in accordance with the mechanical provisions for avoiding accidental discharge and the various proper procedures for loading and unloading. No person should handle any firearm without first having thoroughly familiarized himself with the particular type of firearm he is using, and with safe gun handling in general.



2. ALWAYS KEEP THE MUZZLE POINTED IN A

Be sure of the bullet stop behind your target, even when dry-firing. Never let the muzzle of a firearm point at any part of your body or at another person. This is particularly important when loading or unloading a firearm. In the event of an accidental discharge, no injury can occur as long as the muzzle is pointing in a safe direction. A safe direction means a direction that will not permit a

discharged bullet to strike a person, or to strike an object from which the bullet may ricochet.

A safe direction must take into account the fact that a bullet may penetrate a wall, ceiling, floor, window, etc., and strike a person or damage property. Make it a habit to know exactly where the muzzle of your gun is pointing whenever you handle it, and be sure that you are always in control of the direction in which the muzzle is pointing, even if you fall or stumble. Keep your finger off the trigger until you are ready to shoot.

3. FIREARMS SHOULD BE UNLOADED WHEN NOT IN USE.



Firearms should be loaded only when you are in the field or on the target range or shooting area, ready to shoot. Firearms and ammunition should be securely locked in safes, racks or cabinets, or by using the locking device supplied with the firearm, when not in use. Ammunition should safely be stored separate from firearms. Store your firearms out of sight of visitors and children. It is the gun owner's responsibility to be certain that children and

persons unfamiliar with firearms cannot gain access to firearms, ammunition, or components.

4. BE SURE THE BARREL IS CLEAR OF OBSTRUCTIONS BEFORE SHOOTING.

Even a bit of mud, snow or excess lubricating oil or grease in the bore may cause the barrel to bulge, or even burst on firing, and can cause serious injury to the shooter and bystanders. Be sure that you are using ammunition of the proper caliber and loading for the gun you are using. If the report or recoil on firing seems weak, or doesn't seem quite right, CEASE FIRING IMMEDIATELY, unload your firearm, and check to be sure that no obstruction has become lodged in the barrel. Never try to shoot out an obstruction!

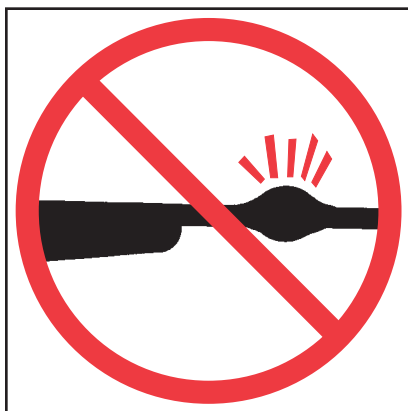



5. BE SURE OF YOUR TARGET BEFORE YOU SHOOT.

Don't shoot unless you know exactly where your bullet is going to strike. Be sure of the bullet stop behind your target, even when dry-firing with an unloaded gun. If you are in the field hunting, do not fire at a movement or noise. Take the time to be absolutely certain of your target before you pull the trigger.

6. WEAR SHOOTING GLASSES AND HEARING PROTECTION WHEN YOU SHOOT.

All shooters should wear protective shooting glasses and adequate hearing protection when shooting. Exposure to shooting noise can damage hearing, and wearing adequate eye protection when shooting is essential.



7. NEVER CLIMB A TREE OR FENCE WITH A LOADED FIREARM.

Put the firearm down carefully before climbing a fence, and unload it before climbing or descending a tree or jumping over a ditch or other obstruction. Never pull or push a loaded firearm toward yourself or another person. When in doubt, or whenever you are about to do anything awkward, unload your gun!

8. DON'T SHOOT AT A HARD SURFACE OR AT WATER.

Bullets can glance off many surfaces like rocks or the surface of water and travel in unpredictable directions with considerable velocity.



9. NEVER TRANSPORT A LOADED FIREARM.

Firearms should always be unloaded before being placed in a vehicle. A suitable carrying case or scabbard should be used to carry an unloaded firearm to and from the shooting area.

10. AVOID ALCOHOLIC BEVERAGES WHEN SHOOTING.

Don't drink until the day's shooting is over. Handling firearms while under the influence of alcohol in any form, or medications that could affect your judgment or coordination, constitutes a criminal disregard for the safety of others.



A BRIEF ACCOUNT OF AN EXTRAORDINARY ACHIEVEMENT: RUGER® FIREARMS

Sturm, Ruger & Company, Inc., had its beginning in a small machine shop occupying a rented frame building in Southport, Connecticut. In January, 1949, with an initial investment of only \$50,000 and an idea, William B. Ruger and Alexander M. Sturm started production of a .22 caliber autoloading pistol—a design which was so successful that it became the cornerstone upon which one of the most comprehensive lines of sporting firearms ever made in America was established. After Alex Sturm's death in 1951, William B. Ruger continued to direct the Company until his death in 2002. William B. Ruger, Jr. continued to provide guidance, which helped make this Company a sound and successful enterprise, until his retirement in 2006. The Company has continued to prosper, under new management and guidance from our Board, with new products and fresh perspectives.

Ruger, in this relatively short time, has established itself as a leading small arms design organization, developing a unique and broad line of fine quality sporting, military and police firearms to become one of the world's most famous producers of revolvers, pistols, rifles and shotguns. Since 1949, Ruger craftsmen have built many millions of firearms.

During its five decades of growth and progress under the leadership of William B. Ruger, the Company developed a business philosophy and implemented policies which represent a constructive influence in the life of modern America. From the beginning, Ruger played a positive role in conservation efforts and has supported the interests of shooters through such groups as the National Rifle Association, National Shooting Sports Foundation, and many regional sportsmen's organizations.

The Company has always endeavored to market its firearms for constructive and recreational purposes, to emphasize the traditional and responsible aspects of shooting, to render meaningful public services, and to encourage shooters in constructive, responsible, and safe participation in the shooting sports. Its motto, "Arms Makers For Responsible Citizens®," exemplifies this Company philosophy.

Today, Ruger® is particularly mindful of those elements which have contributed to the creation of its success, and extends heartfelt thanks to its many loyal employees and customers.

The firearms catalog, and instruction manuals for all Ruger® firearms, can be downloaded from our website at:

Ruger.com

NOTES

WHY NO WARRANTY CARD HAS BEEN PACKED WITH THIS NEW RUGER® FIREARM

The Magnuson-Moss Act (Public Law 93-637) does not require any seller or manufacturer of a consumer product to give a written warranty. It does provide that if a written warranty is given, it must be designated as "limited" or as "full" and sets minimum standards for a "full" warranty. Sturm, Ruger & Company, Inc. has elected not to provide any written warranty, either "limited" or "full", rather than to attempt to comply with the provisions of the Magnuson-Moss Act and the regulations issued thereunder. There are certain implied warranties under state law with respect to sales of consumer goods. As the extent and interpretation of these implied warranties varies from state to state, you should refer to your state statutes. Sturm, Ruger & Company wishes to assure its customers of its continued interest in providing service to owners of Ruger® firearms.



STURM, RUGER & COMPANY, INC.
411 SUNAPEE STREET
NEWPORT, NEW HAMPSHIRE 03773 U.S.A.
RUGER.COM

ARMS MAKERS FOR RESPONSIBLE CITIZENS®

**A COPY OF THE INSTRUCTION MANUAL FOR ANY RUGER®
FIREARM IS AVAILABLE FROM THE FACTORY FREE ON REQUEST, OR IT MAY BE
DOWNLOADED FROM OUR WEBSITE AT RUGER.COM.
THESE INSTRUCTION MANUALS CONTAIN IMPORTANT
WARNINGS WHICH MUST BE UNDERSTOOD
BEFORE USING THESE FIREARMS.**

The Following are Sturm, Ruger & Co., Inc. Trademarks: "BX-Trigger," "Bisley," Eagle Hard "R" logo holding gun, "Elite 452," "Gold Label," "I'm a Ruger American," "LC6," "LCR-357," "LC380CA," "Mark II," "Mark III," "Model 96," "P345," "P345D," "P345PR," "P85," "P90," "P91," "P93," "P94," "P95," "P97," "R.I.O.S.," "Ruger-57," "Ruger Marksman Adjustable," "Ruger 77/50," "Ruger 10/17," "Ruger Titanium," "Security-Six," "Service-Six," "77/357," "Single-Seven," "Speed-Six," "SR45," "SR-556C," "SR-556VT," "SR-762," "Super Bearcat," "Target Grey," "10/22-FS," "This is Ruger. This is America.," "Tri-Flex," "22 Charger," "22/45," and "22/45 RP."

The Following are Registered U.S. Trademarks Belonging to Sturm, Ruger & Co., Inc.: "AC-556," "AR-556," "Arms Makers For Responsible Citizens," "All-Weather," "Bearcat," "Blackhawk," "BX-15," "BX-25," Eagle 'R' - soft 'R' & hard 'R,' Eagle 'SR,' "EC9s," "Everything you need and nothing you don't.," "GP100," "Hawkeye," "It's Mine and It's American," "It's Mine. And It's American.," "LC380," "LC9," "LC9s," "LC9s Pro," "LCP," "LCR," "LCRx," "M77," "Match Champion," "Mini Thirty," "Mini-14," "9E," "Old Army," "Power Bedding," "Redhawk," "RUGER," "Ruger American Pistol," "Ruger American Pistol" flag design, "Ruger American," "Ruger American Rifle," "Ruger American Rimfire," "Ruger Custom Shop," "Ruger Hunting" - phrase & logo design, "Ruger Inside & Out" - phrase & logo design, "Ruger Precision," "Ruger Precision Rifle," "Ruger 77/17," "Ruger 77/22," "Ruger 77/44," "Ruger SP101," "Ruger 10/22 Takedown" phrase & logo design, "Ruger 22/45 Lite," "Ruger Vaquero," "Rugged, Reliable Firearms," "Security-9," "Silent-SR," "Single-Nine," "Single-Six," "Single-Ten," the "SR" Design, "SR9," "SR9c," "SR40," "SR40c," "SR-22," "SR22," "SR-556," "SR-556 Takedown," "SR1911," "Super Redhawk Alaskan," "10/22," "10/22 Takedown," and "Wrangler."